

# CAMARGUE®

## PRODUCT INFORMATION





# TABLE OF CONTENTS

<b>Description</b> .....	<b>3</b>
<b>Benefits</b> .....	<b>4</b>
Design .....	4
Quality .....	5
Customisation .....	6
Comfort .....	6
<b>Technical details</b> .....	<b>7</b>
Standard configuration .....	8
Camargue > 6200 mm .....	9
Camargue weight .....	10
Camargue snow load .....	11
<b>Accessories</b> .....	<b>12</b>
<b>Certificates &amp; testing</b> .....	<b>14</b>
<b>Configuration</b> .....	<b>15</b>
Type .....	15
Construction method .....	19
Columns .....	21
Comfort Pack .....	23
Profiles .....	24
Waterproof wall mounting .....	25
Blade orientation .....	26
Mounting bases .....	27
Water drainage .....	29
<b>Other tools</b> .....	<b>30</b>





## DESCRIPTION

**Modular aluminium patio cover with rotating blades and integrated side elements.**

- Can be controlled using the Renson® Connect App, io or RTS
- Modular support structure
- Integrated side elements and accessories
- Can be joined in multiple parts on both the span and pivot side, even after first installation

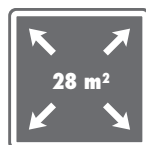

One roof section



SUN  
PROTECTION

VENTILATING

WATER-  
RESISTANT

# BENEFITS

## Design

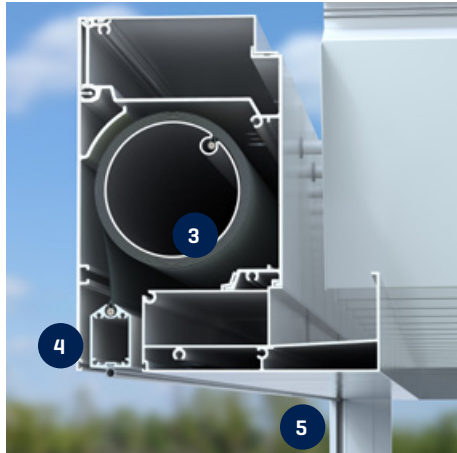

### 1 MODULAR DESIGN

Expandable to include multiple roof sections, even after initial installation. The structure can be endlessly expanded on both the span and pivot side to cover large surface areas.

### 2 INVISIBLE SCREWS

Create an elegant and sleek structure

### 3 THE FABRIC ROLLER TUBE IS FULLY INTEGRATED INTO THE STRUCTURE

#### INNOVATION

No visible screen head box disrupting the aesthetic

### 4 THE BOTTOM BAR DISAPPEARS INTO THE HEAD BOX

### 5 FIXSCREEN SIDE GUIDING CHANNELS ARE INTEGRATED INTO THE COLUMNS

#### INNOVATION

Full aesthetic integration with the Camargue structure

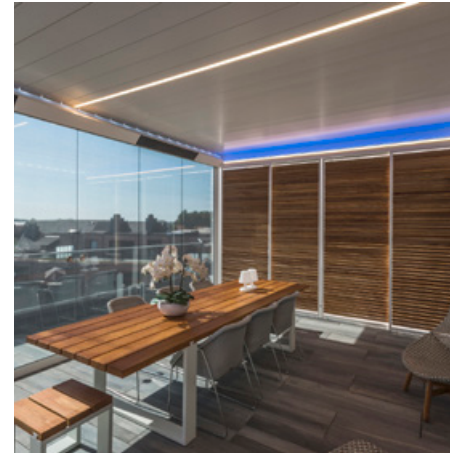

### 6 MINIMAL GAPS BETWEEN THE BLADES

Lend a stunning and sleek finish

### 7 INTEGRATED MOTOR

Forms a stunning minimalist design, without a motor disrupting the aesthetic.

## Quality

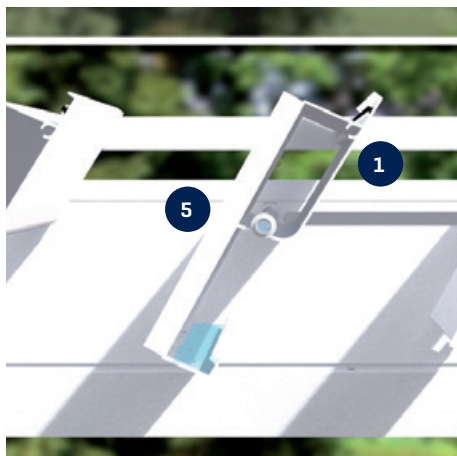

### 1 DOUBLE-WALLED BLADES FOR EXTRA STRENGTH

Load-bearing capacity: 200 kg/m<sup>2</sup>

### 2 F2 TECHNOLOGY

#### INNOVATION

With a span system that ensures the rigidity of its support structure, Camargue remains stable even in strong winds [pivot  $\geq$  4.5 metres]

### 3 UNIQUE END CAPS

Provide a solid corner connection and perfect water drainage

### 4 NO HOLES IN THE WATER CHANNEL

An additional chamber means no holes need to be drilled in the water channel when affixing side infills

### 5 WELDED ALUMINIUM DRIPS, POWDER-COATED TO MATCH THE BLADE COLOUR

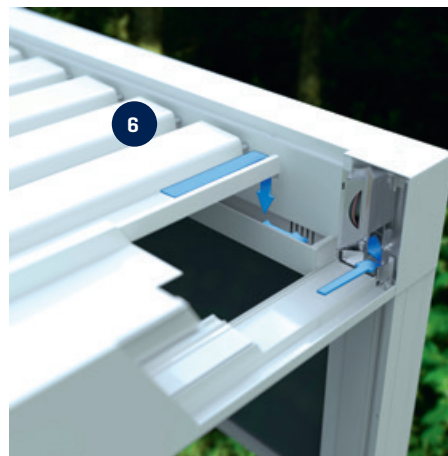
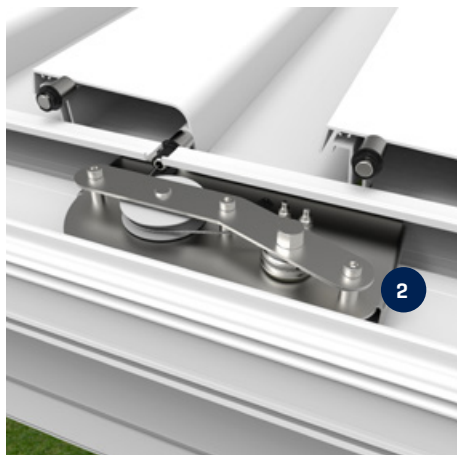

### 6 INTEGRATED WATER DRAINAGE WITH LARGE FLOW

Through the wide blade gutters, water flows towards gutters with diffusers to prevent splashing before being drained via PVC drainpipes integrated into the columns.

### 7 RIGID STRUCTURE

Span system lends rigidity to the support structure

## Customisation



### **1 WIDEST RANGE OF SIDE INFILLS**

---

### **2 BACK ORDERS POSSIBLE**

---

### **3 ACCESSORIES**

---

For more information about the possible accessories, see the 'Accessories' section and/or the product information for the various accessories.

## Comfort

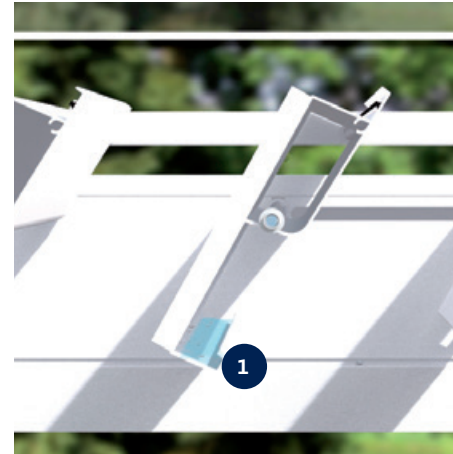

### **1 SPECIALLY DEVELOPED GUTTER BORDER**

---

#### **INNOVATION**

Prevents the patio and furniture from getting wet when the blades are opened after a rain shower

### **2 SILENT AND SOFT CLOSING MECHANISM**

---

By adding a brush to the blades

### **3 QUICK INSTALLATION**

---

Thanks to maximum pre-assembly and the modular structure of the various junctions

### **4 MAXIMUM NATURAL LIGHT**

---

Blades open up to 150°



# TECHNICAL DETAILS

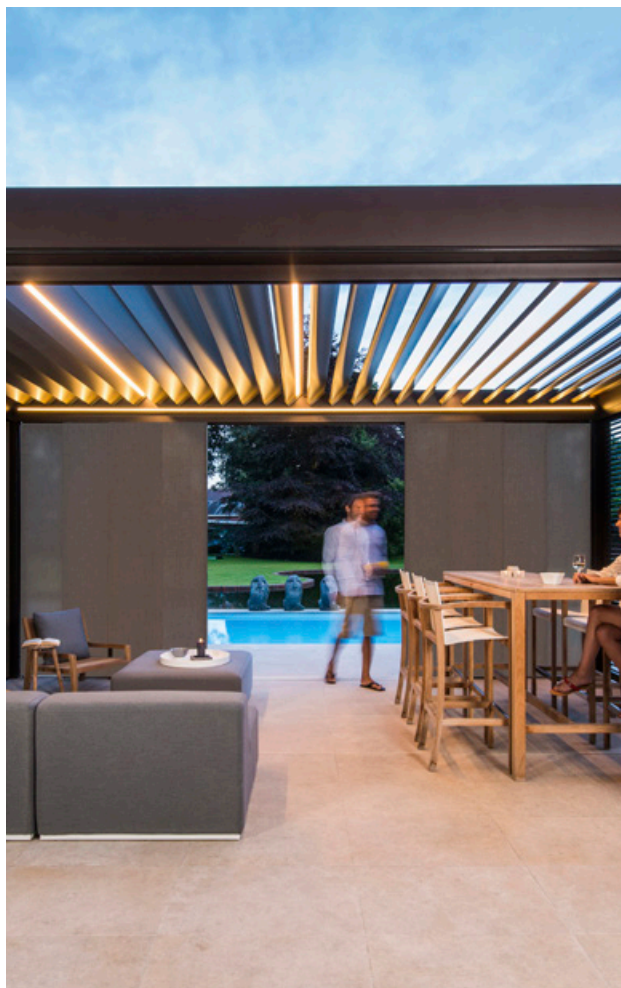

Dimensions	
Span	Min. 1800* mm - max. 4500 mm
Pivot	Min. 1800* - max. 6200 mm / 7060 mm**
Passage height	Min. 415 mm - max. 2800 mm
Total height with blades closed	Passage height + 260 mm
Total height with blades 90° open	Passage height + 355 mm
Minimum height required when installed under a roof overhang	Passage height + 365 mm
Blade rotation	Max. 150°
Minimum number of water drainage points < 16 m <sup>2</sup>	1
Minimum number of water drainage points > 16 m <sup>2</sup>	2***
Operating methods	
Renson® Connect App	✓
Somfy io	✓
Somfy RTS	✓
Home automation ready	✓

\* Smaller dimensions [span min. 500 mm and pivot min. 1256 mm] possible by special request to pre-sales - drawing office

\*\* Pivot > 6200 mm possible subject to a number of conditions. See the "Camargue > 6200 mm".

\*\*\* Please note: If only one column is used, the water drainage capacity will be limited to 0.025 l/m<sup>2</sup>.s [90 l/h]

## Electrical bladed roof drive

Parameters	Value
Supply voltage	230 Volt AC, 50 Hz
Transformer current range	0 - 2.5 Ampère
Transformer power	100 W
Motor voltage	24 Volt DC
Motor nominal current	3 Ampère
Protection rating	IP 66 Dynamic
Maximum running time with continuous use	Approx. 2 minutes
Automatic	16 A curve C



## Standard configuration

### Structure

- Free-standing or façade mounted [against whole wall or partial connection]
- Standard mounting bases [visible, invisible or cast]
- Custom span, pivot and passage height with mm precision
- Motor drive with choice of motor position
- Blade orientation [sun protection or maximum sunlight]

### Finish

- Seaside Quality A
- Monocolour or dual colour according to Renson® standard colours
- Integrated water drainage [incl. PVC drainage pipes and anti-splash diffusers in the gutter]
- Adjustable installation and drainage holes



## Camargue > 6200 mm

- Maximum pivot dimension: 7060 mm
- Maximum span dimension: 4000 mm (once pivot length is greater than 6200 mm)
- Number of columns per free-standing pivot side: minimum three.
- Maximum free space between two columns: 5900 mm
- Shifted column: NOT possible
- Join on the pivot side to obtain a longer span: NOT possible
- Join on the span side to obtain a longer pivot: IS possible
- Minimum number of water drainage points: three, of which two on the lowest side
- Heat & Sound Beam: NOT possible on the pivot side
- Maximum number of Led blades: 3
- Maximum number of glass blades: 5
- Maximum number of Lineo Fix / Heat blades: 4

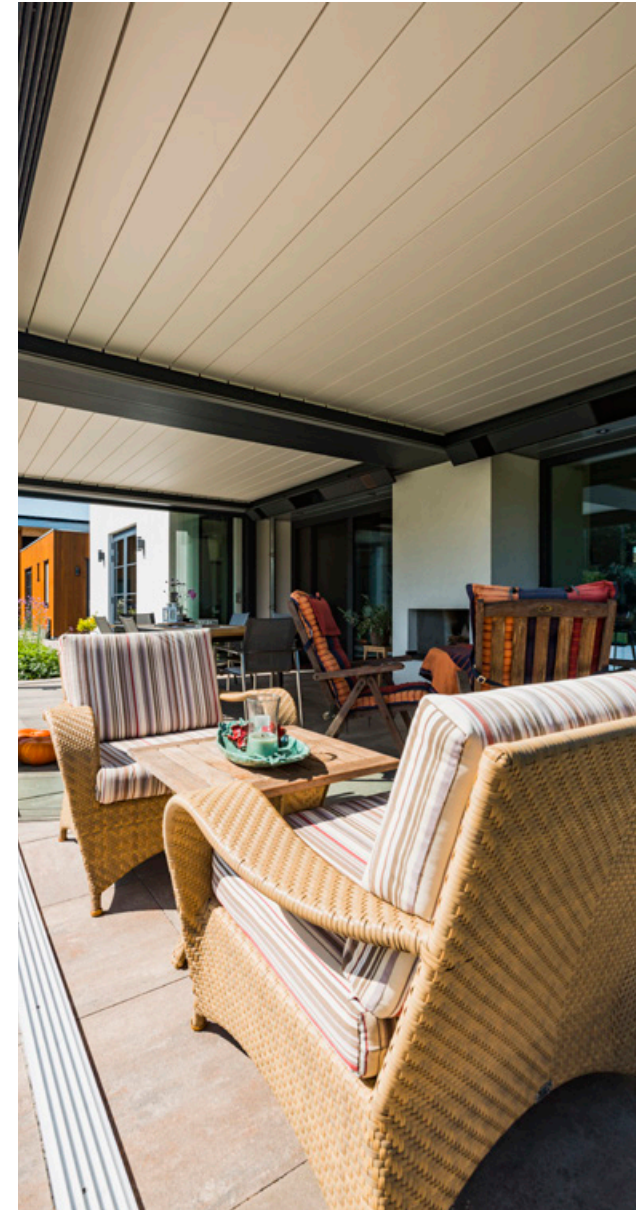

## Camargue weight

		Total weight [kg] of entire Camargue														
		Span														
Pivot	Dimensions in mm	# blades	2000	2200	2400	2600	2800	3000	3200	3400	3600	3800	4000	4200	4400	4500
		2760	10	245	256	266	277	288	299	310	320	331	342	353	364	374
	2975	11	255	266	278	289	300	312	323	335	346	357	369	380	392	397
	3190	12	265	277	289	301	313	325	337	349	361	373	385	397	409	415
	3405	13	274	287	300	312	325	338	350	363	376	388	401	414	426	433
	3620	14	284	298	311	324	337	351	364	377	391	404	417	430	444	450
	3835	15	294	308	322	336	350	364	378	392	405	419	433	447	461	468
	4050	16	304	319	333	348	362	377	391	406	420	435	449	464	478	486
	4265	17	314	329	344	359	375	390	405	420	435	450	465	480	496	503
	4480	18	324	340	355	371	387	403	418	434	450	466	481	497	513	521
	4695	19	334	350	367	383	399	416	432	448	465	481	498	514	530	538
	4910	20	344	361	378	395	412	429	446	463	480	497	514	531	548	556
	5125	21	354	371	389	406	424	442	459	477	494	512	530	547	565	574
	5340	22	363	382	400	418	436	455	473	491	509	528	546	564	582	591
	5555	23	373	392	411	430	449	468	486	505	524	543	562	581	600	609
	5770	24	383	403	422	442	461	481	500	519	539	558	578	597	617	627
	5985	25	393	413	433	453	473	494	514	534	554	574	594	614	634	644
	6200	26	403	424	444	465	486	506	527	548	569	589	610	631	652	662
	6415	27	413	434	455	477	498	519	541	562	583	605	626			
	6630	28	423	445	467	489	511	532	554	576	598	620	642			
	6845	29	433	455	478	500	523	545	568	591	613	636	658			
	7060	30	442	466	489	512	535	558	582	605	628	651	674			

The table above shows the weight of the frame; the weight of the columns and mounting bases is not included. Each column in the configuration adds an extra weight of 5.7 kg/column metre.

### Standard mounting base weight

- invisible mounting base: 2050 g
- cast mounting base: 3590 g
- visible mounting base: 4450 g
- visible [corner]: 3085 g

### Reinforced mounting base weight

- invisible mounting base: 7240 g
- visible mounting base: 11285 g
- visible [corner]: 9010 g

## Camargue snow load

		Maximum snow load Camargue [kg/m <sup>2</sup> ]										
		Span										
Pivot	Dimensions in mm	2000	2250	2500	2750	3000	3250	3500	3750	4000	4250	4500
	4000	866	563	385	273	199	149	113	87	68	53	41
	4250	866	563	385	273	199	149	113	87	68	53	41
	4500	866	563	385	273	199	149	113	87	68	53	41
	4750	862	563	385	273	199	149	113	87	68	53	41
	5000	727	563	385	273	199	149	113	87	68	53	41
	5250	619	536	385	273	199	149	113	87	68	53	41
	5500	530	459	385	273	199	149	113	87	68	53	41
	5750	457	395	348	273	199	149	113	87	68	53	41
	6000	396	342	301	268	199	149	113	87	68	53	41
6200	354	306	269	240	199	149	113	87	68	53	41	

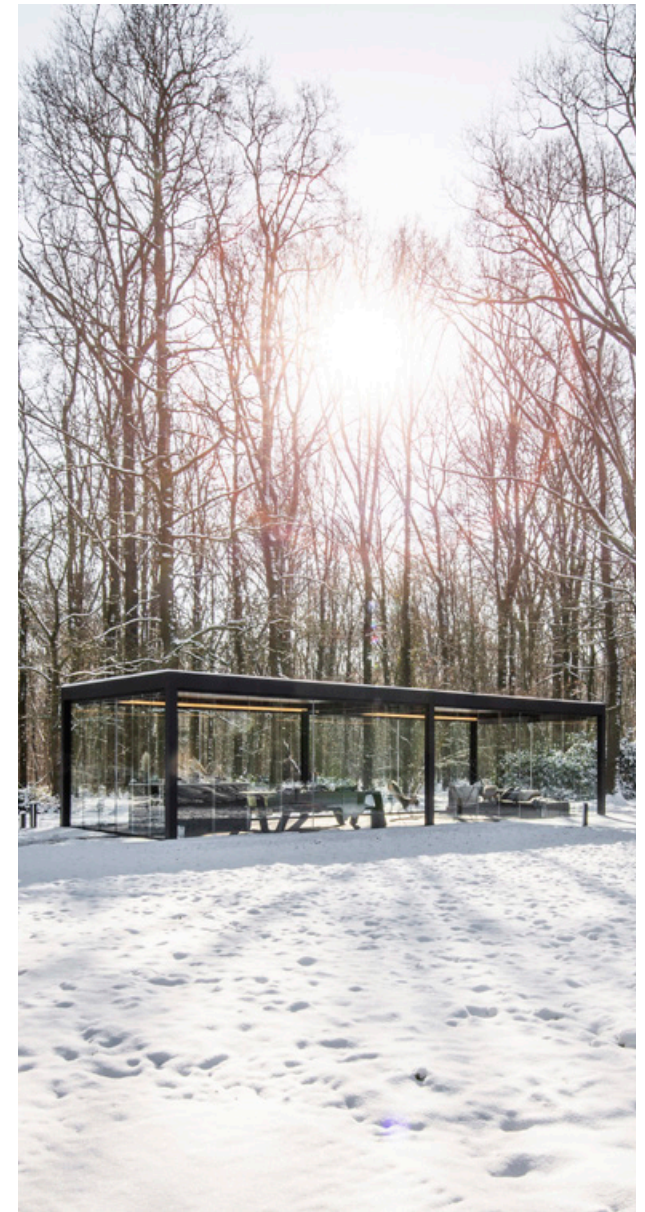



# ACCESSORIES



Comfort pack		Back order
Fixscreen + Lineo Led	-	-
<b>Side infills</b>		
Integrated Fixscreen	✓	✓
Algarve Fixscreen	-	-
Lapure Fixscreen	-	-
Triangle	-	-
Loggia sliding panels	✓	✓
Loggiascreen Canvas sliding door	✓	✓
Glass sliding panels*	✓	✓
Linius wall*	✓	✓
Linarte wall*	✓	✓
Outdoor curtains	✓	✓
<b>Comfort</b>		
<b>Lighting</b>		
Lineo Led	✓	✓
UpDown Led	✓	✓
Colomno Led	✓	-
Lapure Led	-	-
<b>Comfort and design</b>		
Beam Heat & Sound	✓	✓
Lineo Luce	✓	✓
Lineo Fix	✓	✓
Lineo Heat	✓	✓
Waterproof wall mounting	✓	-
Protecto protective profile	✓	✓
<b>Automation</b>		
Wind sensor	✓	✓
Rain sensor	✓	✓
Sun sensor	-	-

\* subject to use of reinforced mounting bases on adjacent columns

Styling		Back order
Classic Line	-	-
Wooddesign roof blades	✓	✓
Columns		
Extra column	✓	-
Shifted column	✓	-
Adjustable wall column	✓	-



# CERTIFICATES & TESTING

## CE – DoP documents

- CE / UKCA / DoC / DoP / ETA
- EUROCODE CALCULATIONS / abZ\*

## Certificates

- Miami Dade – NOA
- UL / ETL certificate US – Canada / CCC
- REACH / seaside/coastal powder coating guarantee
- RoHS / AluEco
- VMRG sun protection

## Declarations

- Declaration of material codes
- Declaration of testing – overview
- Declaration of powder coating
- Declaration of anodisation layer thickness
- Declaration of glass properties
- Declaration of fire resistance / reaction
- Declaration of endurance cycles
- Declaration of safety resistance water pocket
- Declaration of electrical safety
- Declaration of UV resistance / gtot + others
- Declaration of asbestos

## Test reports – calculations

- Water testing / sand resistance test / IP test
- Cycle testing
- Wind [load] testing / verification certificate
- Static load test / calculation
- Environmental statement [recycled aluminium]
- Anchoring requirements
- Gravity-wind load deflection & structural test
- Wind resistance, air flow of the blades

Wind guarantee of roof with blades closed	up to 160 km/h
Wind guarantee of roof with blades open	/**
Fixscreen wind guarantee when closed	up to 60 km/h
Max. wind speed for roof or Fixscreen operation	up to 50 km/h
Water drainage flow	150 l/m <sup>2</sup> /h
Load-bearing capacity	200 kg/m <sup>2</sup>

\* abZ: for Linarte infill

\*\* We recommend against opening the blades in high winds > 50 km/h, as there is a risk that the blades may start vibrating and operating the blades is only permitted up to 50 km/h.





# CONFIGURATION

## Type

Single

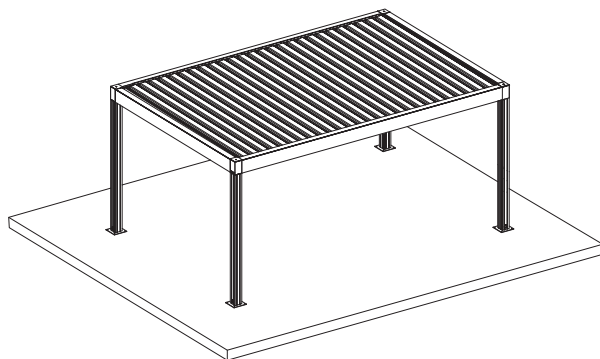

*Free-standing*

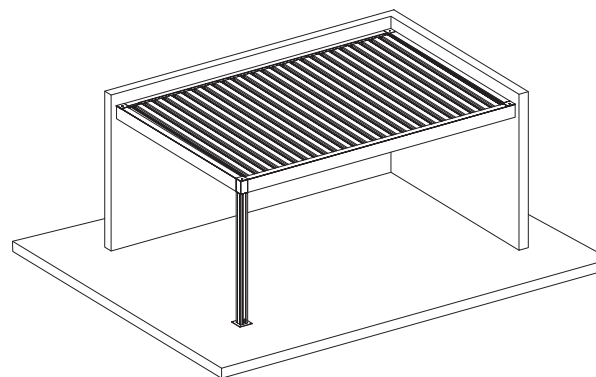

*Façade-mounted on span and pivot side*

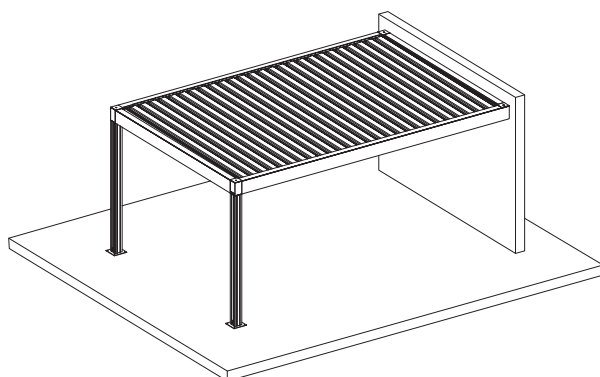

*Façade-mounted on span side*

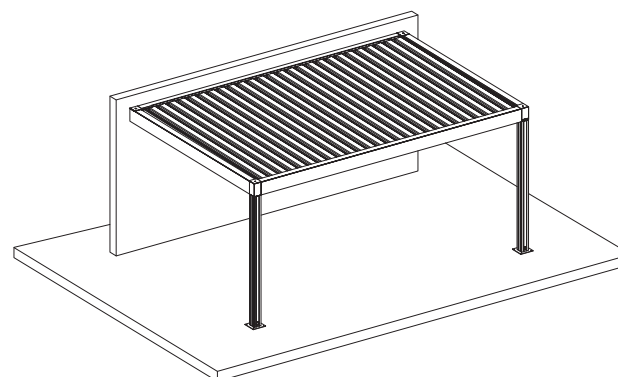

*Façade-mounted on pivot side*

Two sections joined on pivot side

**Free-standing**

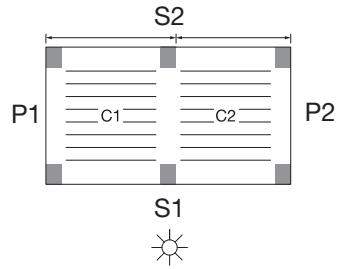

*Two roof sections + six columns*

**Façade-mounted on span side**

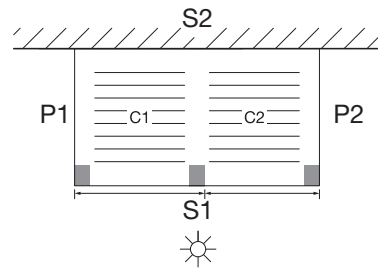

*Two roof sections + three columns*

**Façade-mounted on pivot side**

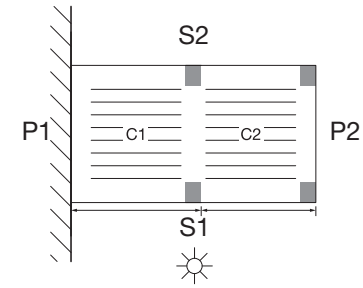

*Two roof sections + four columns*

Three sections joined on pivot side

**Free-standing**

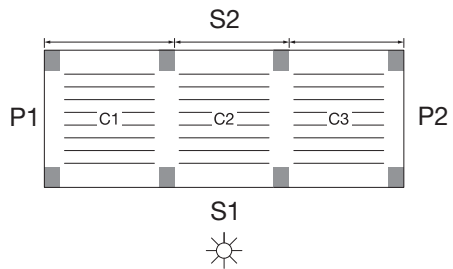

*Three roof sections + eight columns*

**Façade-mounted on span side**

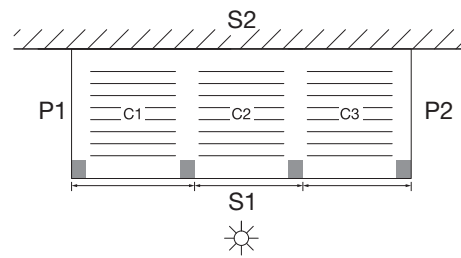

*Three roof sections + four columns*

**Façade-mounted on pivot side**

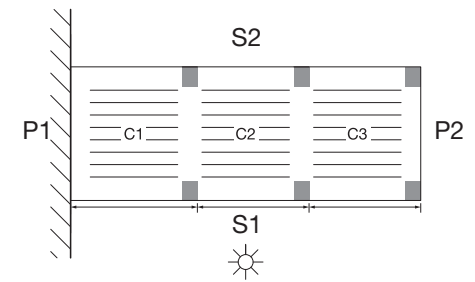

*Three roof sections + six columns*

Two sections joined on span side

**Free-standing**

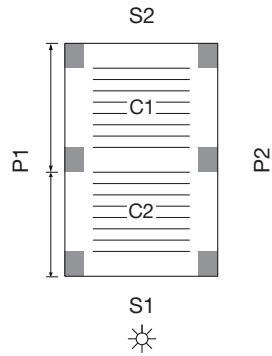

Two roof sections + six columns

**Façade-mounted on span side**

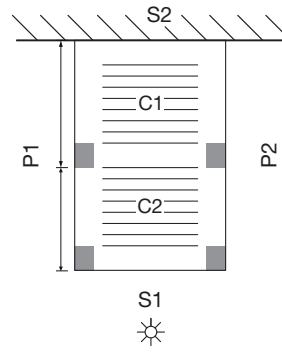

Two roof sections + four columns

**Façade-mounted on pivot side**

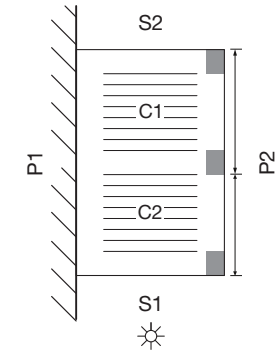

Two roof sections + three columns

Three sections joined on span side

**Free-standing**

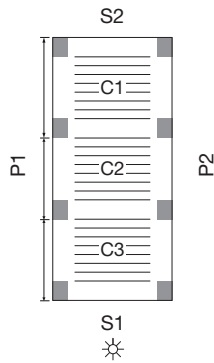

Three roof sections + eight columns

**Façade-mounted on span side**

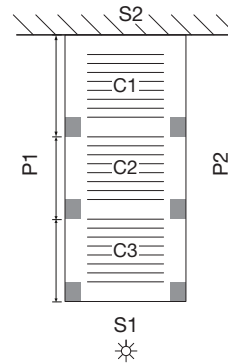

Three roof sections + six columns

**Façade-mounted on pivot side**

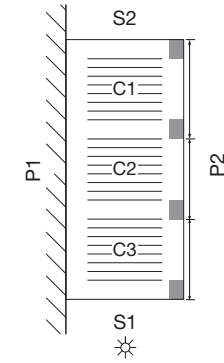

Three roof sections + four columns



Matrix shape

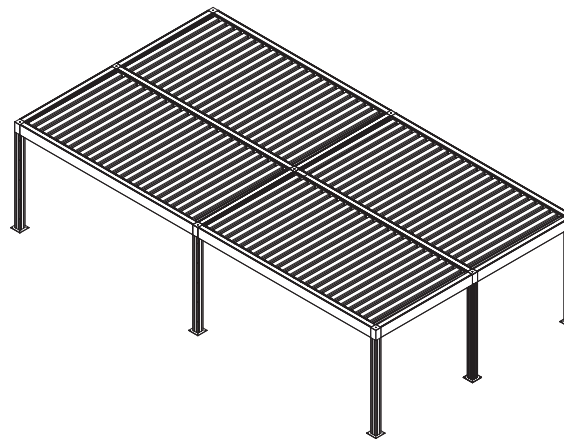
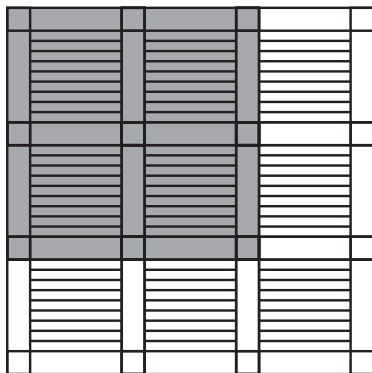

*only possible via presales*

L shape

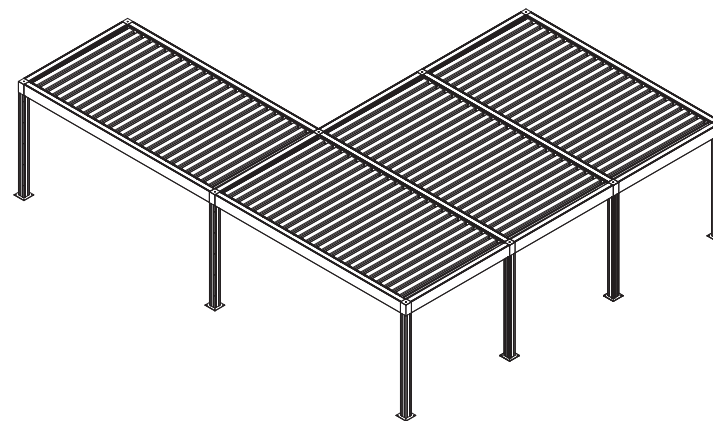
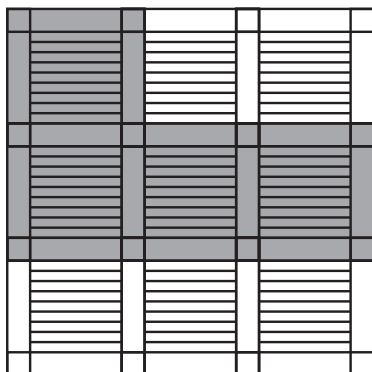

*only possible via presales*

## Construction method

Free-standing

The sides are completely separate from any walls; the cover is not mounted against any walls.

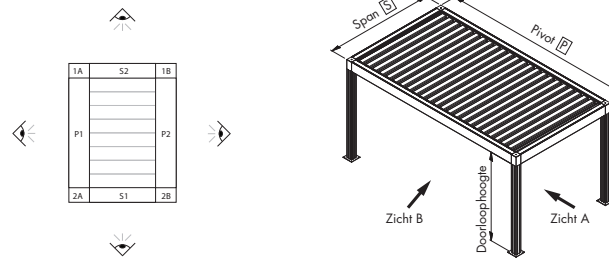

Full-length wall mounted

The full length of the side is mounted against a wall.

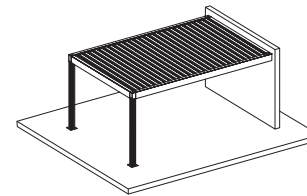
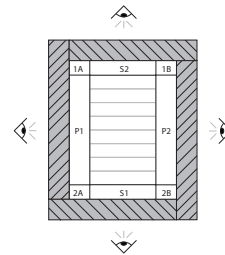

full-length wall mounted [façade mounted] on span side

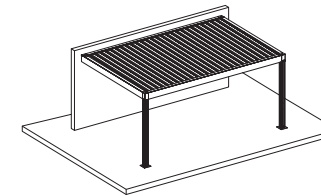

full-length wall mounted [façade mounted] on pivot side

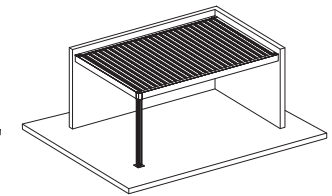

full-length wall mounted [façade mounted] on span and pivot side

Wall to the left

Only part of the side is mounted against a wall. Viewed from outside of the cover, the wall is located on the left side of the beam.

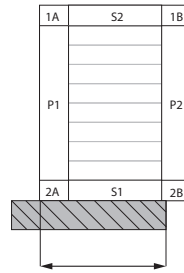

wall length

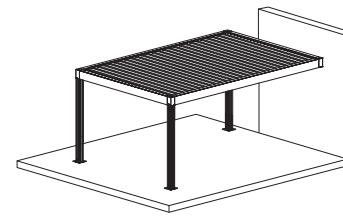

wall to the left [span]

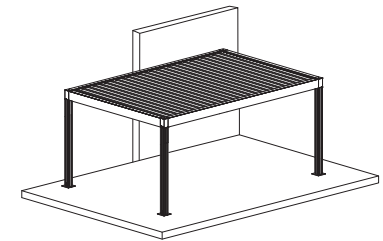

wall to the left [pivot]

Wall to the right

Only part of the side is mounted against a wall. Viewed from outside of the cover, the wall is located on the right side of the beam.

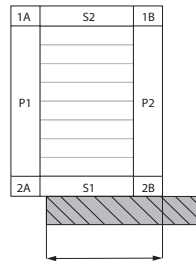

wall length

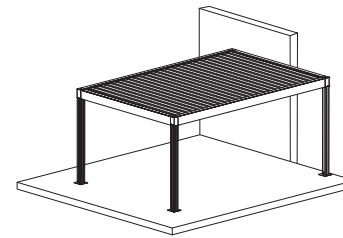

wall to the right [span]

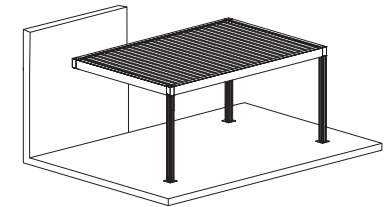

wall to the right [pivot]

Wall in the middle

A limited part of the cover is mounted against a wall. There is a free-standing section of the cover both to the left and to the right of the wall.

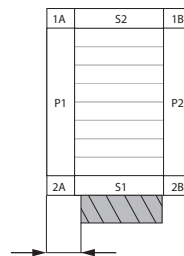

distance on the left to the wall

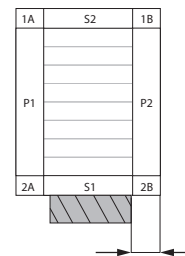

distance on the right to the wall

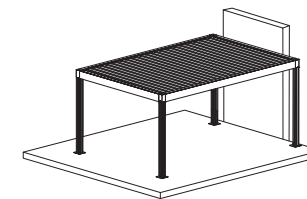

wall in the middle [span]

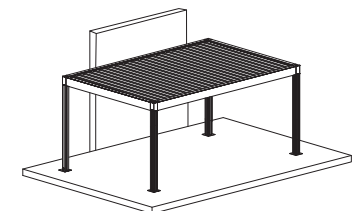

wall in the middle [pivot]

## Columns

### Corner column

A column is provided for each corner as standard. When installing against a wall that guarantees sufficient stability, the column on this side may be omitted.

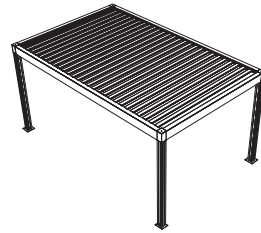

### Shifted column

A column may be shifted in the direction of the pivot to a maximum of 1/5 of the pivot length. This guarantees the stability of the construction at all times.

A shifted column in Camargue and Camargue Skye is entered by entering the required distance from the corner. It is not possible to shift a column in the span direction.

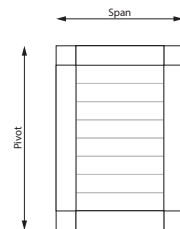
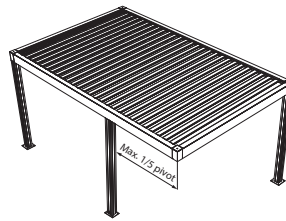

### Adjustable wall column

When installing Fixscreens at a right angle to a façade, a column must be fitted. Given the fact that outside walls are not always built perfectly plumb, a visually disruptive opening may form between the wall and the column. An adjustable wall column guarantees a flush connection and compensates for an angle of 1cm to the front or 1cm to the rear.

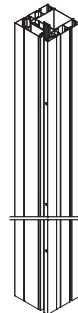
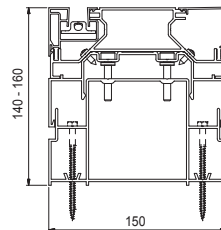

### Shorter/longer columns

A column that is longer (positive overlength) or shorter (negative overlength) than the entered passage height may be ordered. Opting for a positive overlength can be useful to keep a roof perfectly level when your patio slopes downward, for example. Alternatively, if one of the columns is to be installed on a small wall, for example, it can be shortened (negative overlength).

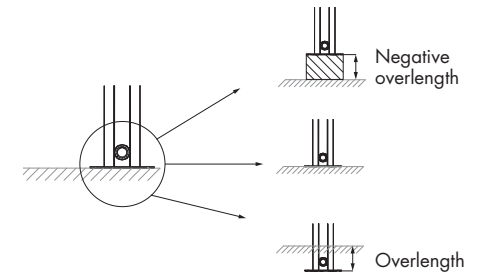
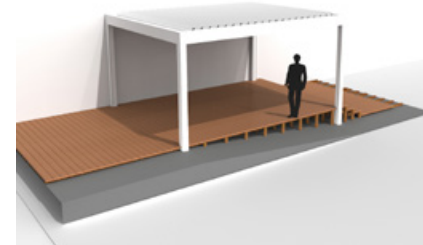

Positive overlength is possible up to the maximum passage height [2800 mm] plus 500 mm [3300 mm].

Negative overlength is possible up to the minimum passage height [= 500 mm].

Overlength only affects the price if the column length >3000 mm.



## Additional column

By adding an additional column, one side of the covering is divided into two parts. The position of the additional column is always viewed from side P1 [additional column on span] or S1 [additional column on pivot].

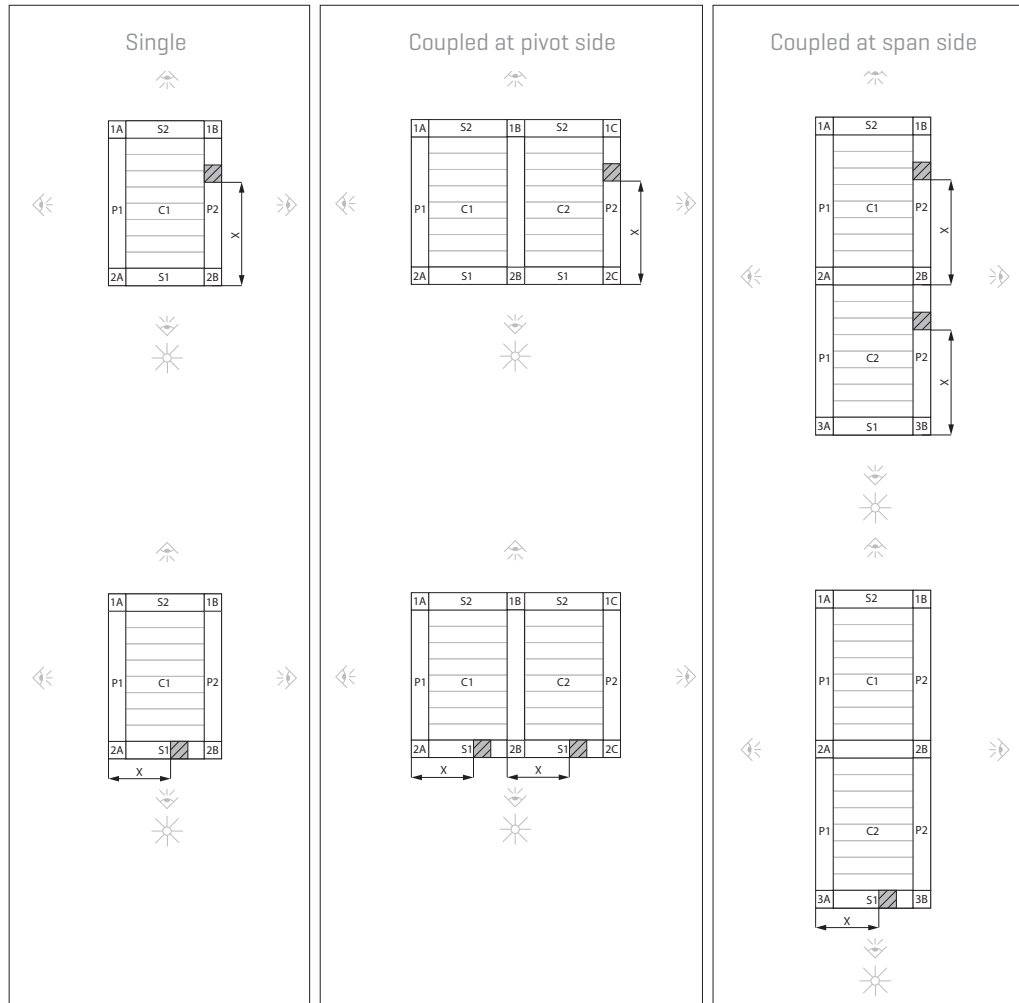
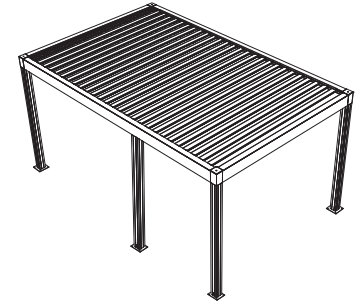

$X$  = position of the intermediate column [mm]

## Comfort Pack

Basic comfort is obtained by equipping Camargue with Fixscreens and Led lighting in the blades.

The combination of Fixscreen[s] and 2 Lineo Led blades are bundled in a package at an interesting price. This comfort pack makes it more economical to add these frequently requested accessories to Camargue.

### **Please note!**

That this comfort pack is only available for:

- Camargue
- All dimensions
- Calculated per roof section
- Minimum 2 Lineo Leds
- Minimum 1 Fixscreen, also possible left and right of an in-between column

# Profiles

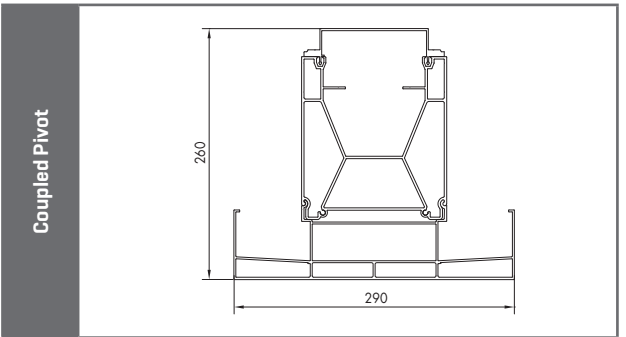
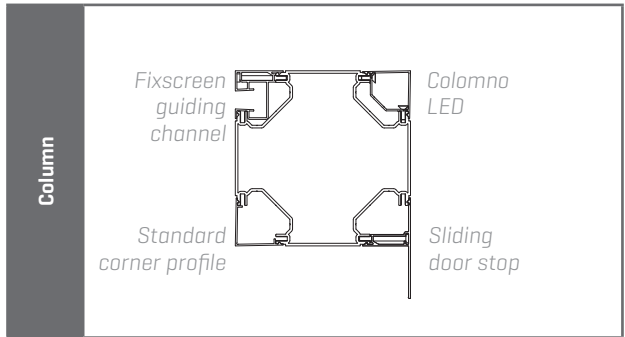
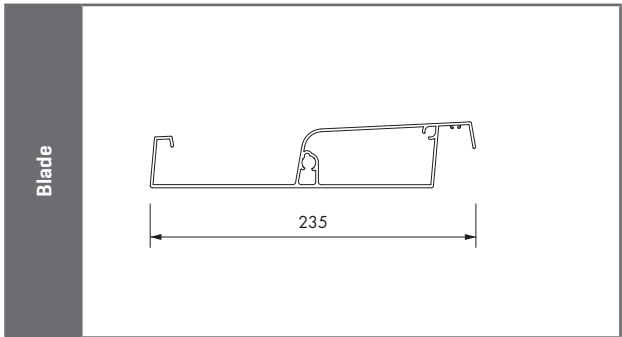
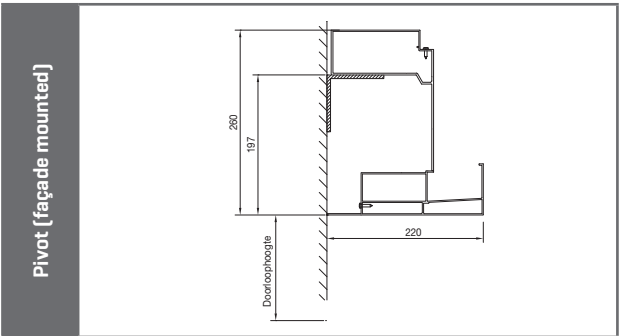
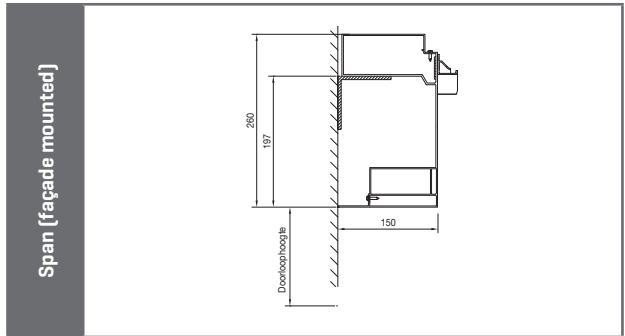
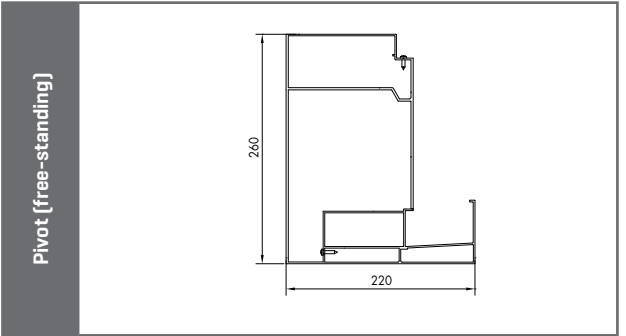
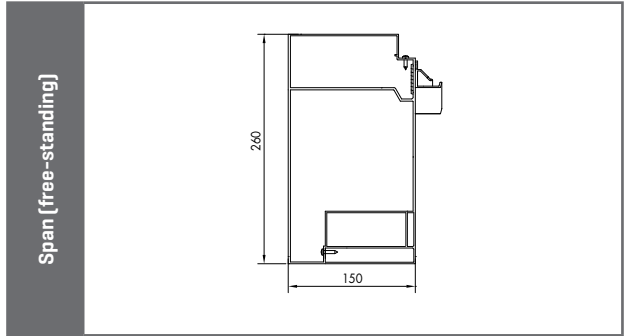
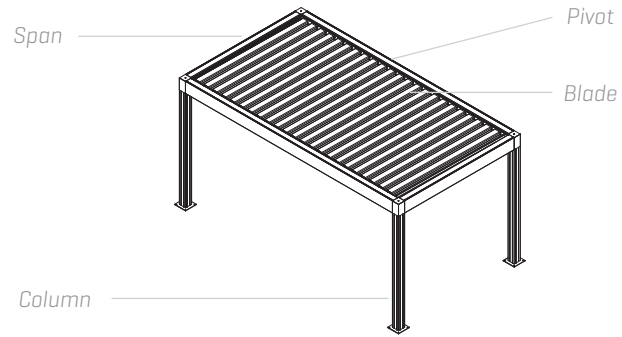

## Waterproof wall mounting

This [optional] solution guarantees a waterproof connection between Camargue and the façade. This is only applicable to covers with a side fully or partially mounted against a wall, and not to free-standing covers placed against a wall.

- Prevents water seepage between the façade and Camargue
- Also sealed against powder snow
- Compensates for irregularities in the façade up to 2 cm
- Easy installation and disassembly
- Controls accessible without removing and re-applying silicone

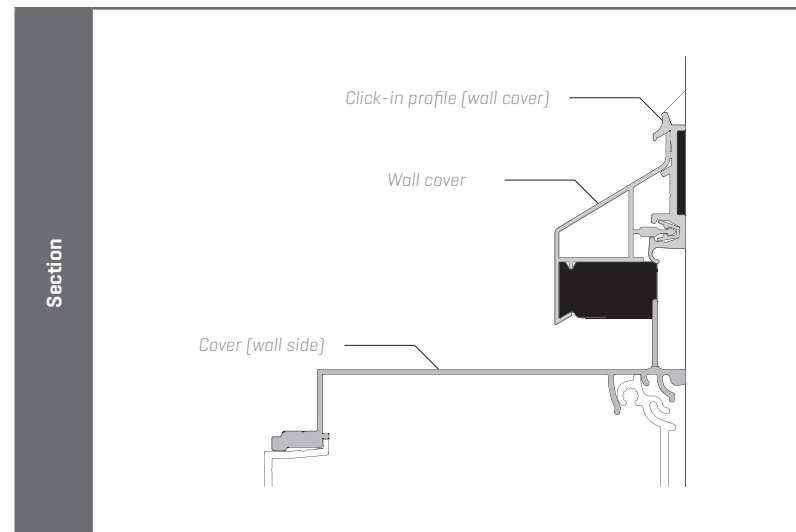
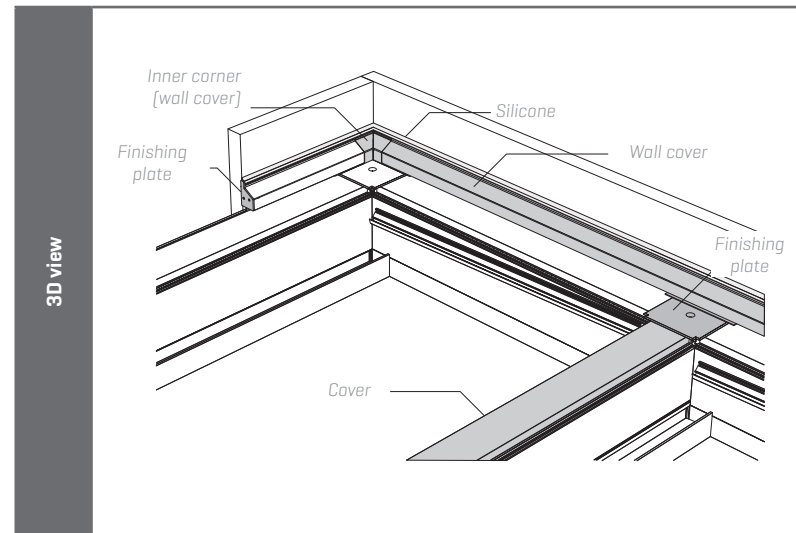



## Blade orientation

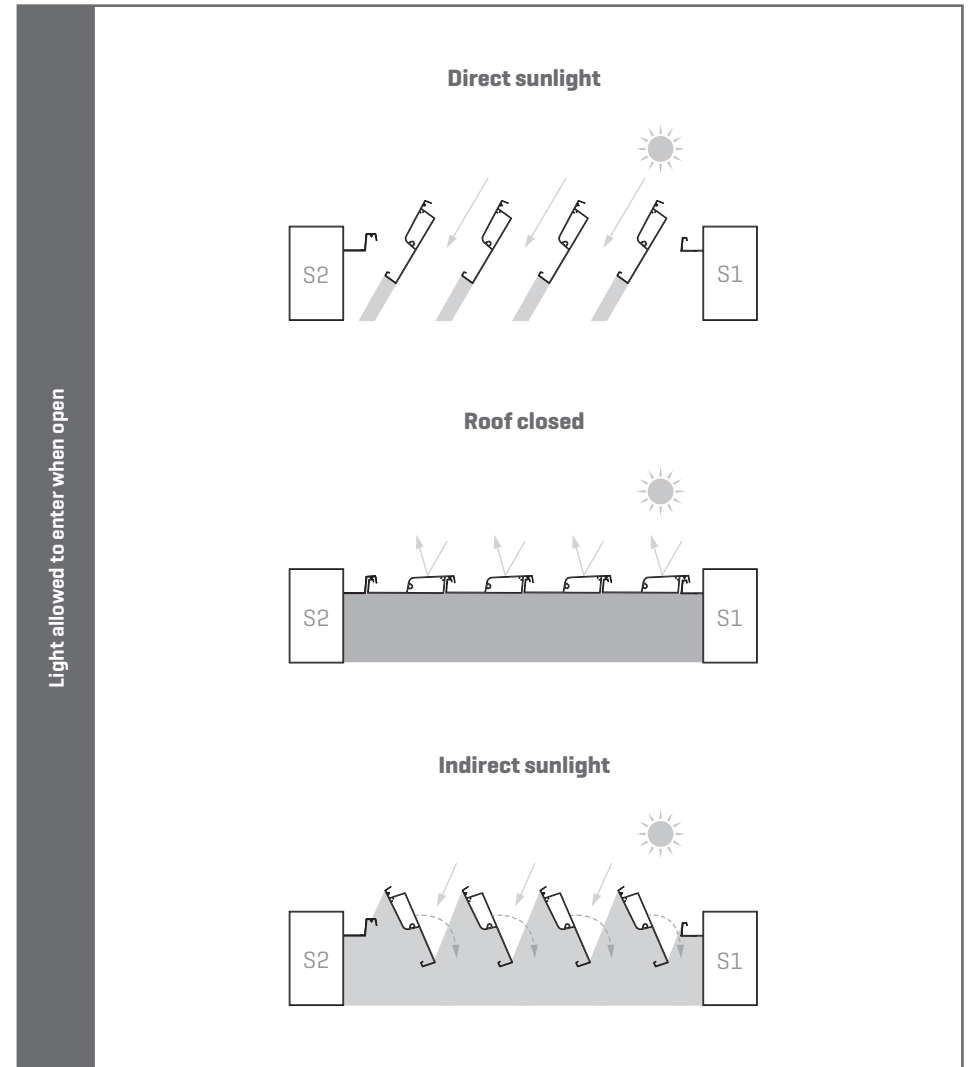
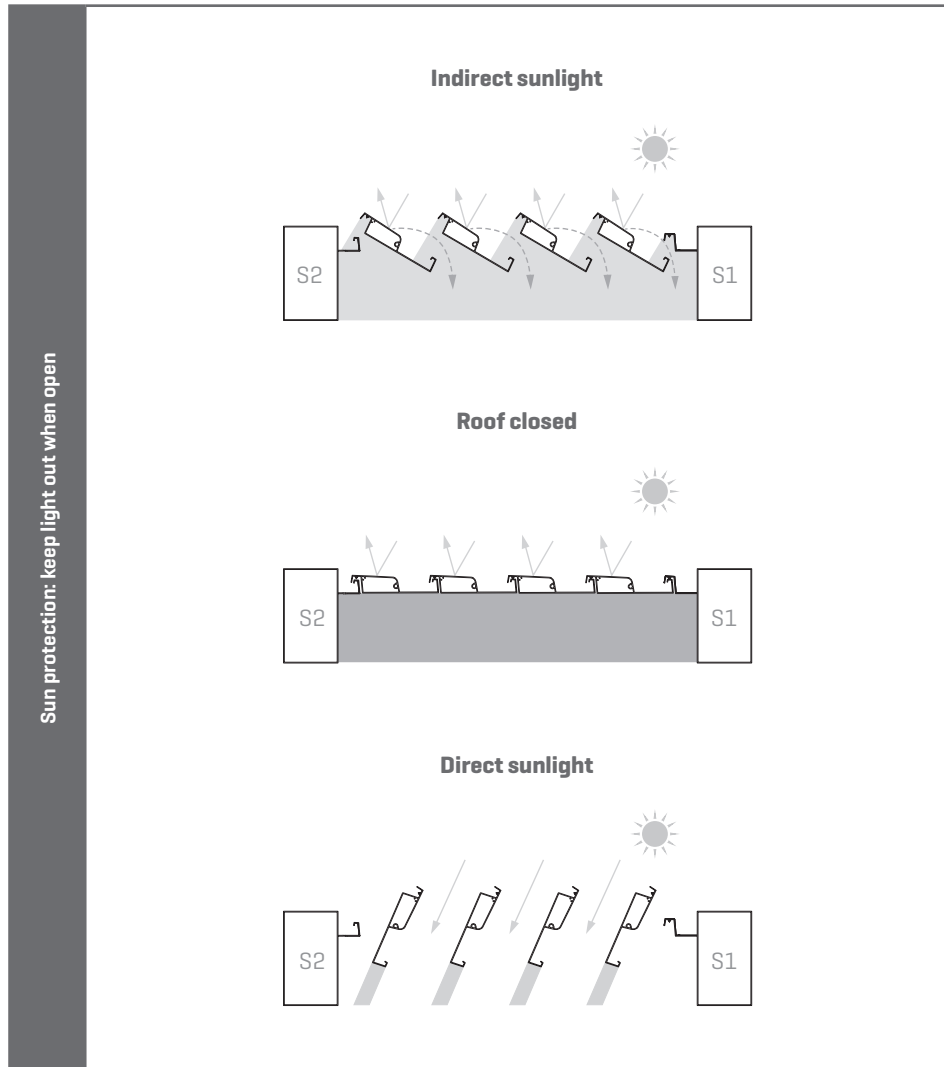

## Mounting bases

The strength requirements determine whether or not reinforced mounting bases are needed.

### Standard mounting bases

For use in normal circumstances, without increased wind load.

- Base plate thickness: 6 mm
- Core length: 300 mm
- Visible base plate: 270 x 270 mm

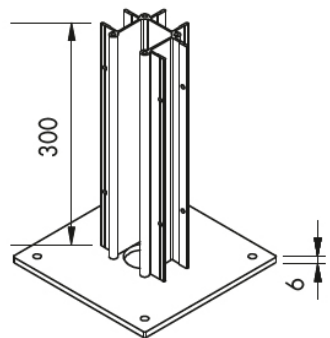

### Reinforced mounting bases

At locations with increased wind loads, the cover must be equipped with reinforced mounting bases to guarantee the stability of the structure. Examples include coastal areas, installation at a height or on a rooftop terrace.

- Base plate thickness: 10 mm
- Core length: 1495 mm
- Visible base plate: 270 x 270 mm

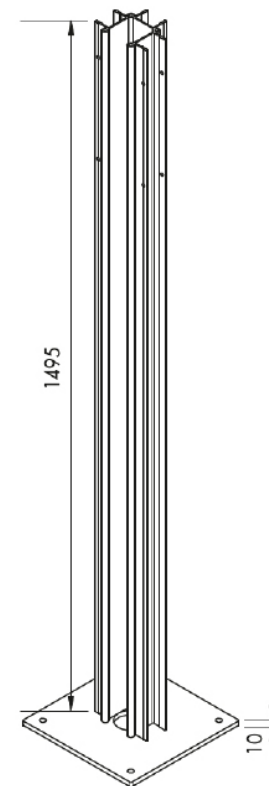

## Mounting bases

The choice of reinforced or non-reinforced mounting bases will be made automatically based on the strength requirements and/or side infill selection. You can select a finish for your mounting bases from the possible options below.

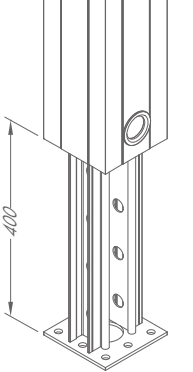
				
<b>Type</b>	Visible mounting base		Invisible mounting base	Cast mounting base
<b>Application</b>	Not against a structure	Pivot or span against a structure	All applications	Cast in concrete foundation
<b>Non-reinforced mounting base</b>	Available at standard price			
<b>Reinforced mounting base</b>	Available at a surcharge			Not available

## Water drainage





Water will be drained down an integrated drainpipe in the columns of your choice. Starting at 16 m<sup>2</sup>, a minimum of two drainage outlets must be arranged for each roof section, of which at least one drain must be on the lowest side of the blades (not on the motor side). For all other dimensions, at least one drain must be arranged on the lowest side of the blades (not on the motor side).

### Please note!

If there is only one water-draining column and the surface area is greater than 16 m<sup>2</sup>, the drainage capacity of the roof will only be 90 litres per hour [0.025 L/m<sup>2</sup>.s].

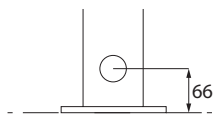
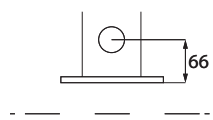
### Three options for the height of the drainpipe:

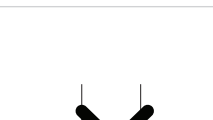
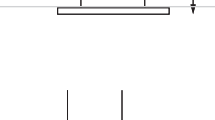
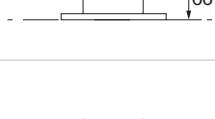
- 66 mm relative to bottom side of the base, regardless of whether or not overlength is applicable [standard].
- 66 mm + overlength relative to the bottom side of the base. In case of overlength, you can choose to have the overlength size included in the standard distance of 66 mm. For example: an overlength of 100 mm means water drainage at 166 mm relative to the bottom side of the mounting base.
- Variable height  
Minimum distance above ground level = 40 mm.  
Maximum distance = passage height – 415 mm.  
The height is always measured from the bottom side of the mounting base to the centre of the drainage hole.

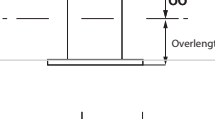
	Passage height	Negative overlength	Positive overlength
66 mm relative to bottom side of base [standard]			
66 mm + overlength relative to bottom side of base			
Variable height [mm]			



# OTHER TOOLS

Want to find out more? Visit the Professional Portal on our website ([www.renson.eu](http://www.renson.eu)) to access the following tools.

- Technical drawings
- Training documents
- Installation manual
- User manual
- [Digital photo book & social media](#)
- ...

