

LÁTKOVÉ ROLETY

ZOOM TECH



Při objednání tohoto produktu si je zákazník vědom skutečnosti, že na tento produkt se vztahuje patent.

Veškeré informace o této technologii zůstávají přísně důvěrné a nemohou být prozrazeny třetím stranám bez předchozího souhlasu společnosti BEMATECH.

Produkt je povinen označit značkou Zoomtech.eu s odkazem na naše vlastnické právo.

Jakékoli zneužití bude řešeno soudním stíháním.

Ikony

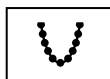

řetízkové ovládání



motor D



motor S



motor S



motor P



rádiová technologie BID



rádiová technologie S

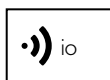

rádiová technologie io

Legenda, kódy

-WM

montáž stěna

-CM

montáž strop

-A

standadní odvíjení látky - látka za trubkou

-B

kontra navíjení látky - látka před trubkou

-L

ovládání vlevo

-R

ovádání vpravo

-FIN..

zátěžová lišta

-RTS; -io; -BID

rádiové ovládání

-CH..

řetízkové ovládání

-MOT..

motorické ovládání

-B..

barevné provedení konzol



PURE 47

objednací kód
LRZ47-CH..



-B01 **-B04** **-B10** **-BRAL**

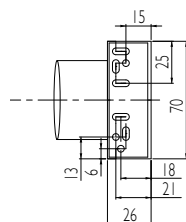
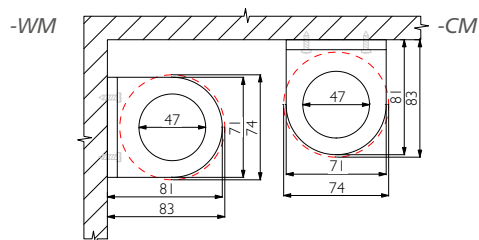
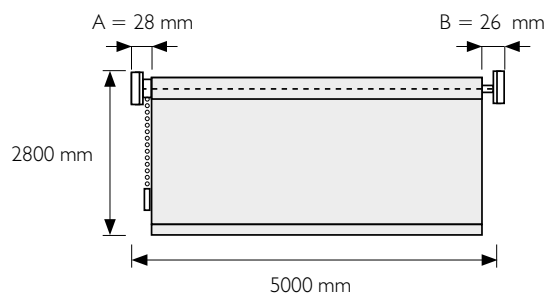

zátěžová lišta

závaží řetízku

řetízek

-FINB

-WE..

-CHNI

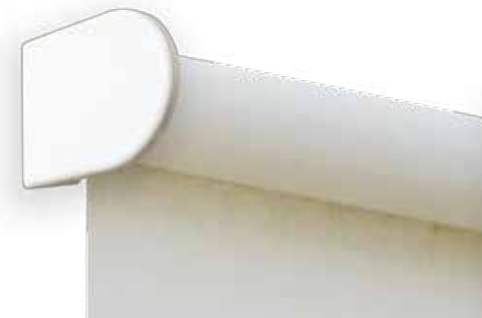

PURE 47

objednací kód
LRZ47-MOTSID



-B01 **-B04** **-B10** **-BRAL**

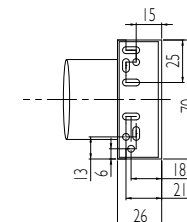
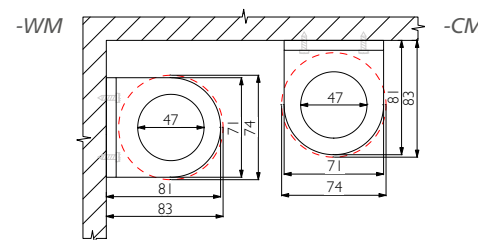
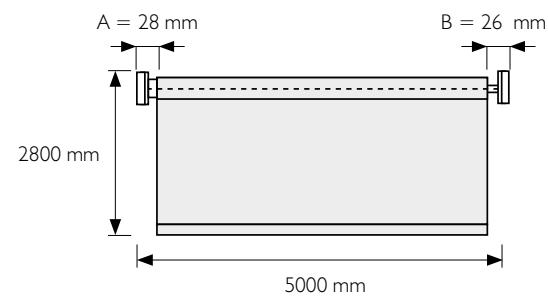

zátěžová lišta

motor D

-FINB

-MOTSID

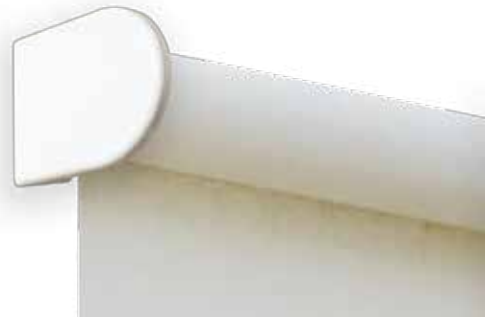

PURE 47
objednávací kód
LRZ47-MOTSIBID

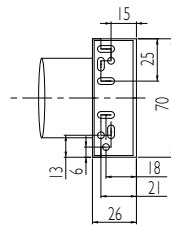
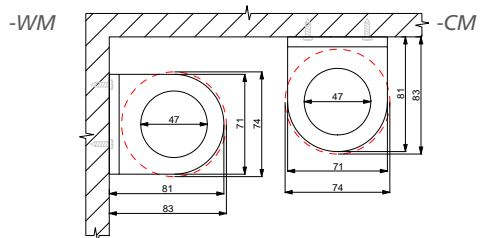
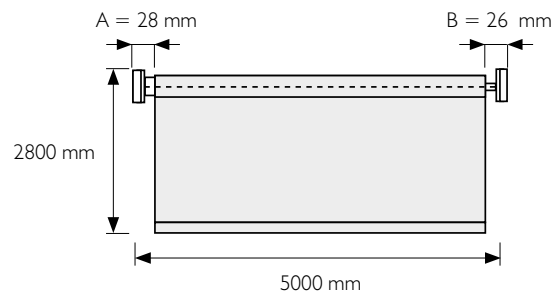
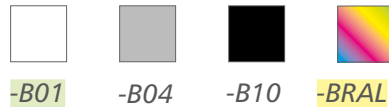

zátěžová lišta

dálkový ovladač BID

motor BID

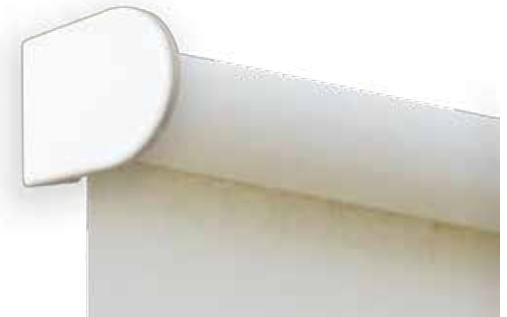
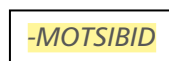
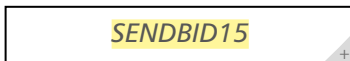

PURE 47
objednávací kód
LRZ47-MOTSIS

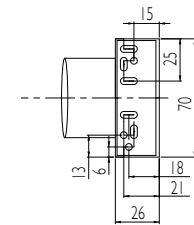
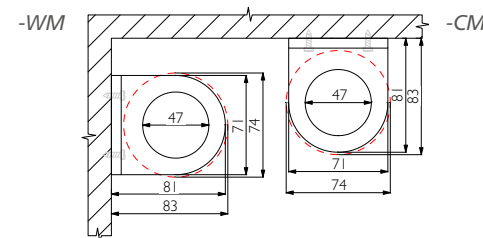
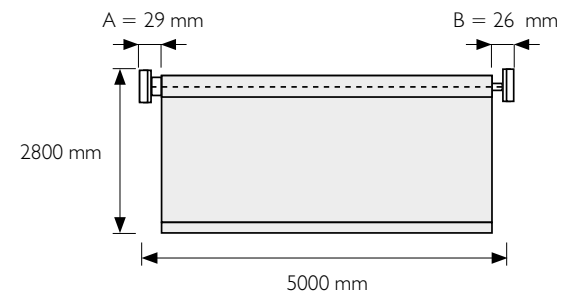
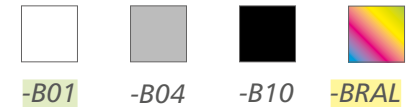

zátěžová lišta

motor S

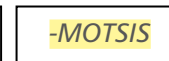
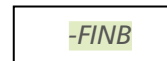

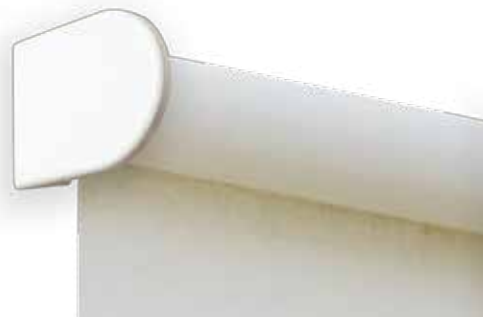

PURE 47
objednací kód
LRZ47-MOTSIRTS

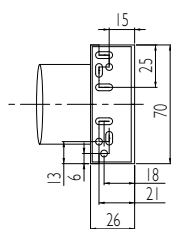
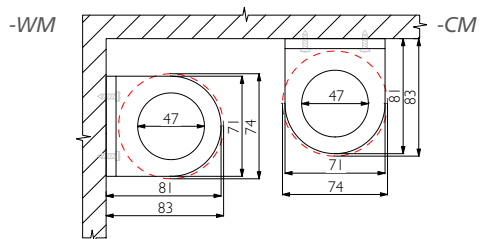
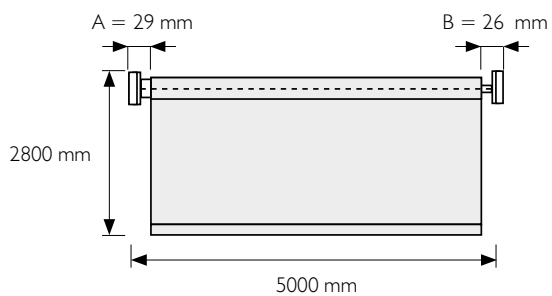

zátěžová lišta

dálkový ovladač RTS

motor RTS

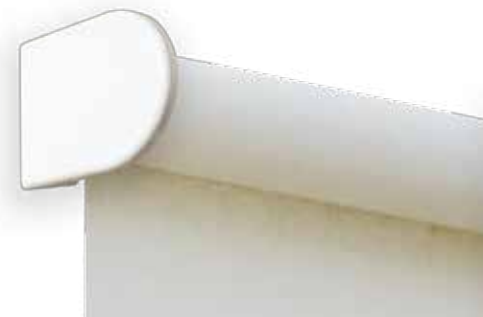
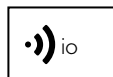
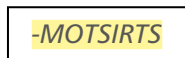
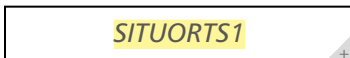

PURE 47
objednací kód
LRZ47-MOTSIIOS

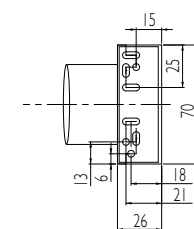
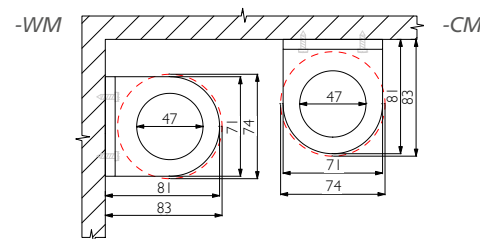
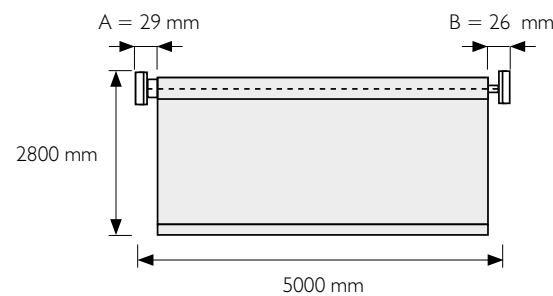

zátěžová lišta

dálkový ovladač iO

motor iO

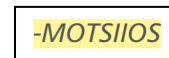
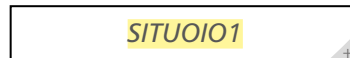

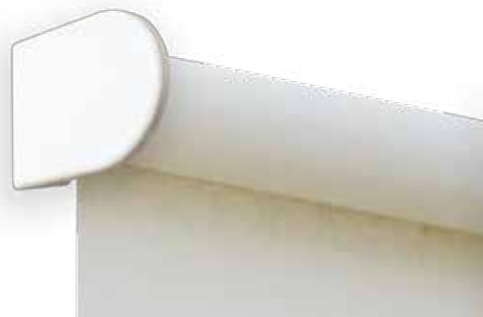

PURE 47

objednací kód

LRZ47-MOTSIPA



-B01



-B04



-B10



-BRAL

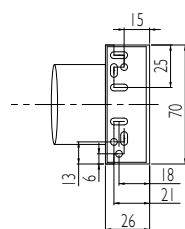
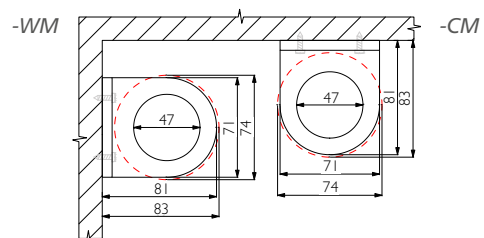
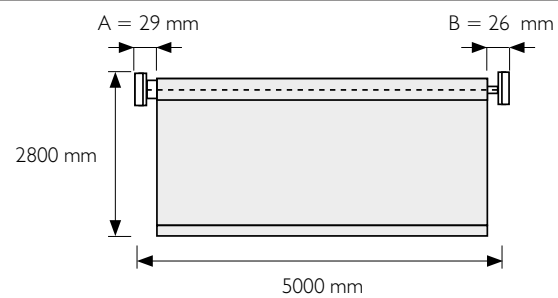

zátěžová lišta

motor PARALLEL

-FINB

-MOTSIPA

Spodní zátěžová lišta

Objednávací
kód
-FIN..

type B
-FINB



- bílá
- černá
- šedá

Designové provedení konzol PURE WOOD

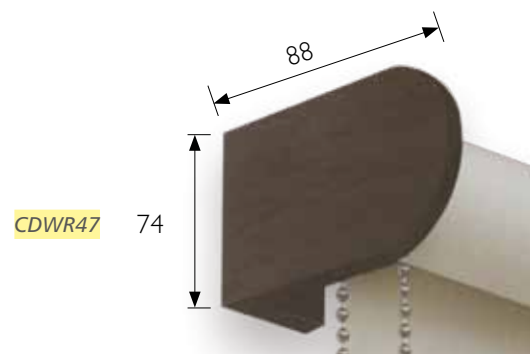
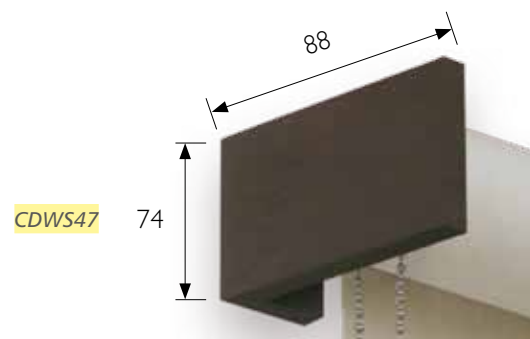

Šířka rolety (pro objednání) je celková šířka bez designových krytek konzol nebo garnýže.

V provedení konzol PURE WOOD se celková šířka rovná objednaní šířka + 5mm (2 x 2,5mm)

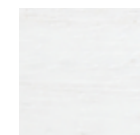

SELENE S01



HARMONIA H03



ENARETE E03



RHEIA R08



PERSES P08

Nekonečný řetízek

Ovládání řetízkem musí být v souladu s normou EN 13120-Ochrana proti nebezpečí uškrcení. Dodaná výška ovládání a event. dodané bezpečnostní prvky jí budou odpovídat.

Objednací
kód
-CH..

nikl satén
-CHNI



bronz
-CHBR

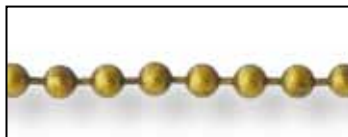

Gun metal
-CHGM

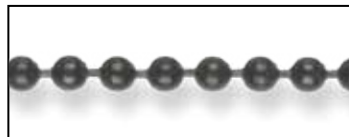

Dungeon
-CHDU

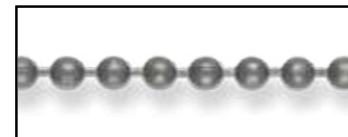

Medieval brass
-CHMB



Mystic red
-CHMR

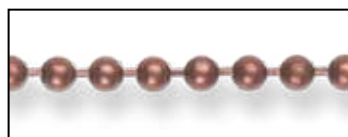

! BEZPEČNOSTNÍ UPOZORNĚNÍ



Nebezpeční uškrcení malých dětí ve smyčce ovládacího řetízku nebo šňůry. Nenechávejte děti bez dozoru blízko ovládacího řetízku nebo šňůry.

Závaží typ 2

rozměr A = 60 mm, B = 48 mm

Objednací
kód
-WE..

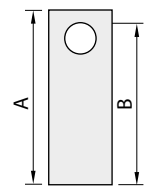

rozměr závaží

bílá
-WE201



šedá
-WE204



černá
-WE210



transparentní
-WE2TR



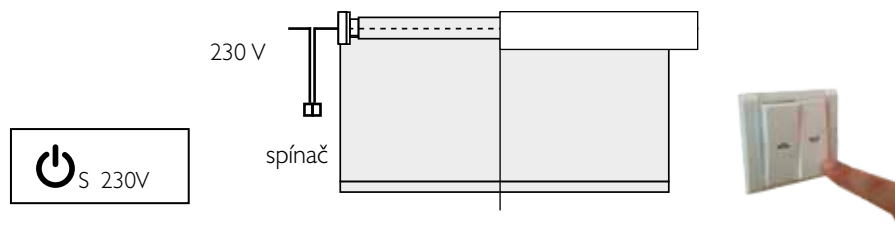

motor S pro drátové ovládání



motor S

Délka bílého kabelu 2,5 m

-MOTSIS

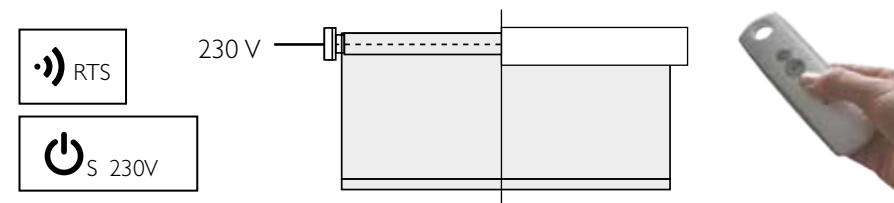

Motor RTS pro bezdrátové ovládání



motor RTS

S integrovaným přijímačem,
délka bílého kabelu 3 m

-MOTSIRTS

Mechanicky nastavitelné koncové polohy na hlavě motoru bez možnosti nastavení mezipolohy.

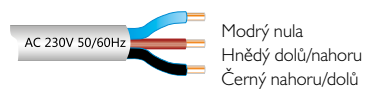

Nikdy nezapojíte více motorů na jeden spínač bez užití relé.



+ dálkový ovladač RTS



RTS)))

1 kanálový vysílač, Situ 1

SITUORTS1



RTS)))

5 kanálový vysílač, Situ 5

SITUORTS5



RTS)))

1 kanálový ovladač nástěnný

Smoove Origin

ORIGIN

Elektronické nastavení s možností mezipolohy.



-PROGRAM uživatelské naprogramování: Na přání zákazníka jsou pozice ovladače nastaveny dle požadovaných instrukcí (kanál – výrobek, párování atd.).

U motorů bez možnosti nastavení mezipolohy, není možné garantovat stejnou polohu rolet mezi koncovými polohami.

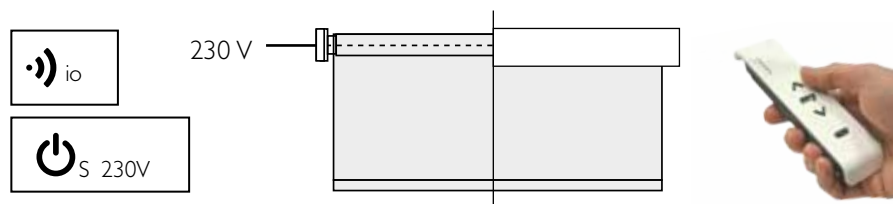

Motor IO pro bezdrátové ovládání



motor io

S integrovaným přijímačem,
délka bílého kabelu 3 m

-MOTSIIOS



+ dálkový ovladač io



io)))

1 kanálový ovladač přenosný

Situo 1

SITUOIO1



io)))

5 kanálový ovladač přenosný

Situo 5

SITUOIO5



io)))

1 kanálový ovladač nástěnný

Smoove Origin io

ORIGINIO

Elektronické nastavení s možností mezipolohy.

AC 230V 50/60Hz



Hnědý silový

Modrý nula

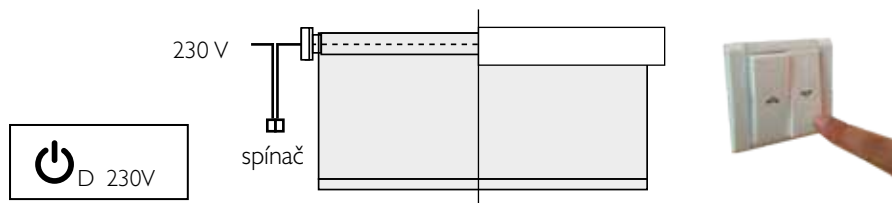

Tichý motor D pro drátové ovládání



Silent motor D

Délka bílého kabelu 3 m

-MOTSID

Mechanicky nastavitelné koncové polohy na hlavě motoru bez možnosti nastavení mezipolohy.



Nikdy nezapojte více motorů na jeden spínač bez užití relé.

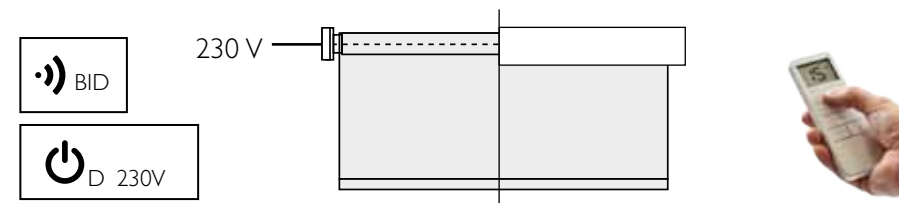

Tichý motor BID pro bezdrátové ovládání



Silent Motor BID

S integrovaným přijímačem,
délka bílého kabelu 3 m

-MOTSIBID

+ BID remote control



15-channel remote SendA I

SENDBID15

Mechanicky nastavitelné koncové polohy na hlavě motoru bez možnosti nastavení mezipolohy.

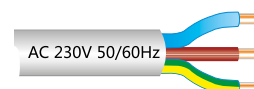

Modrý nula

Hnědý silový

Žlutý/zelený zem

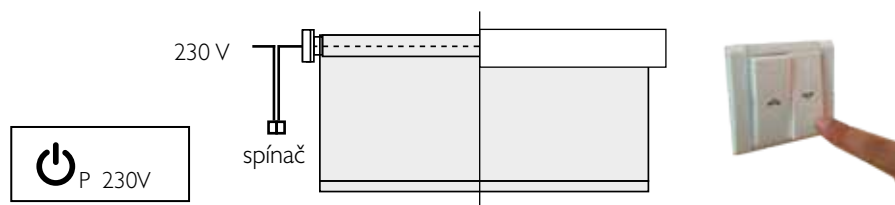

Tichý motor PARALLEL pro drátové ovládání



Tichý motor P

Délka bílého kabelu 3 m

-MOTSIPA

Elektronicky nastavitelné koncové polohy.

